

Professional PTZ Camera

— User Manual —

PTZ211 / PTZ310UV2 / PTZ310UNV2
PTZ231 / PTZ330UV2 / PTZ330UNV2

Warning

- To reduce the risk of fire or electric shock, do not expose this appliance to rain or moisture. Warranty will be void if any unauthorized modifications are done to the product.
- Do not drop the camera or subject it to physical shock.
- Use the correct power supply voltage to avoid the damaging camera.
- Do not place the camera where the cord can be stepped on as this may result in fraying or damage to the lead or the plug.
- Hold the bottom of the camera with both hands to move the camera. Do not grab the lens or lens holder to move the camera.

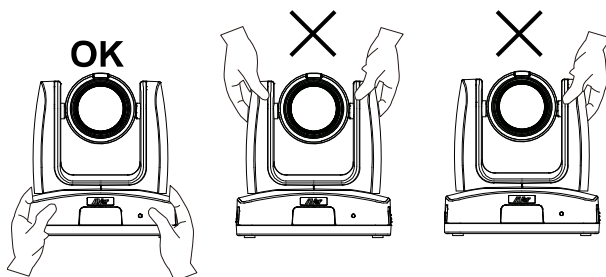

Federal Communications Commission

NOTE: This equipment has been tested and found to comply with the limits for a Class A digital device, pursuant to part 15 of the FCC Rules. These limits are designed to provide reasonable protection against harmful interference when the equipment is operated in a commercial environment. This equipment generates, uses, and can radiate radiofrequency energy and, if not installed and used in accordance with the instruction manual, may cause harmful interference to radio communications. Operation of this equipment in a residential area is likely to cause harmful interference in which case the user will be required to correct the interference at his own expense.

FCC Caution: Any changes or modifications not expressly approved by the party responsible for compliance could void the user's authority to operate this equipment.

This device complies with part 15 of the FCC Rules.

Operation is subject to the following two conditions:

- (1) This device may not cause harmful interference, and
- (2) this device must accept any interference received, including interference that may cause undesired operation.

This Class A digital apparatus complies with Canadian ICES-003. Cet appareil numérique de la classe A est conforme à la norme NMB-003 du Canada.

Warning

This is a class A product. In a domestic environment, this product may cause radio interference in which case the user may be required to take adequate measures.

Caution

Risk of explosion if battery is replaced by an incorrect type. Dispose of used batteries according to the instructions.

VCCI-A

この装置は、クラス A 機器です。この装置を住宅環境で使用すると電波妨害を引き起こすことがあります。この場合には使用者が適切な対策を講ずるよう要求されることがあります。

사용자안내문

이 기기는 업무용 환경에서 사용할 목적으로 적합성평가를 받은 기기로서 가정용 환경에서 사용하는 경우 전자파간섭의 우려가 있습니다.

※ 사용자 안내문은 "업무용 방송통신기자재"에만 적용됩니다.

기종별

사용자안내문

A 급 기기
(업무용 방송통신기자재)

이 기기는 업무용(A 급) 전자파적합기기로서 판매자 또는 사용자는 이 점을 주의하시기 바라며, 가정외의 지역에서 사용하는 것을 목적으로합니다.

DISCLAIMER

No warranty or representation, either expressed or implied, is made with respect to the contents of this documentation, its quality, performance, merchantability, or fitness for a particular purpose. Information presented in this documentation has been carefully checked for reliability; however, no responsibility is assumed for inaccuracies. The information contained in this documentation is subject to change without notice.

In no event will AVer Information Inc. be liable for direct, indirect, special, incidental, or consequential damages arising out of the use or inability to use this product or documentation, even if advised of the possibility of such damages.

TRADEMARKS

"AVer" is a trademark owned by AVer Information Inc. Other trademarks used herein for description purpose only belong to each of their companies.

COPYRIGHT

©2023 AVer Information Inc. All rights reserved. | August 31, 2023

All rights of this object belong to AVer Information Inc. Reproduced or transmitted in any form or by any means without the prior written permission of AVer Information Inc. is prohibited. All information or specifications are subject to change without prior notice.

More Help

For FAQs, technical support, software and user manual download, please visit:

Headquarters

Download Center: <https://www.aver.com/download-center>
Technical Support: <https://www.aver.com/technical-support>

USA Branch Office

Download Center: <https://www.averusa.com/pro-av/support>
Technical Support: <https://averusa.force.com/support/s/contactsupport>

Europe Branch Office

Download Center: <https://www.avereurope.com/download-center>
Technical Support: <https://www.avereurope.com/technical-support>

Contact Information

Headquarters

AVer Information Inc.
<https://www.aver.com>
8F, No.157, Da-An Rd., Tucheng Dist., New Taipei City 23673, Taiwan
Tel: +886 (2) 2269 8535

USA Branch office

AVer Information Inc., Americas
<https://www.averusa.com>
668 Mission Ct., Fremont, CA 94539, USA
Tel: +1 (408) 263 3828
Toll-free: +1 (877) 528 7824
Technical support: support.usa@aver.com

Europe Branch office

AVer Information Europe B.V.
<https://www.avereurope.com>
Westblaak 134, 3012 KM, Rotterdam, The Netherlands
Tel: +31 (0) 10 7600 550
Technical support: eu.rma@aver.com

Japan Branch Office

アバー・インフォメーション株式会社
<https://jp.aver.com>
〒160-0023 日本東京都新宿区西新宿 3-2-26 立花新宿ビル 7 階
Tel: +81 (0) 3 5989 0290
テクニカル・サポート: <https://jp.aver.com/technical-support>

Vietnam Branch Office

Công ty TNHH AVer Information (Việt Nam)
Tầng 5, 596 Nguyễn Đình Chiểu, P.3, Quận 3,
Thành phố Hồ Chí Minh 700000, Việt Nam
Tel: +84 (0)28 22 539 211

Contents

Warning	2
Overview	1
Package Contents	1
Optional Accessories*	1
Parts Info	2
LED Indicators	2
Remote Control.....	3
Dimensions.....	4
Pan and Tilt Angle.....	6
Connection	7
Device Connection.....	7
PoE Connection.....	7
RS-232 and RS-422 Connection	9
Audio Input Connection	14
Video Output Connection.....	15
Installation	16
Cable Fixing Plate Installation	16
Ceiling Mount Installation.....	17
Camera Installation.....	18
Set Up the Camera	19
OSD Menu	19
IP Address Setup	19
Static IP	19
DHCP	20
OSD Menu Tree.....	21
Camera	21
Video Output.....	23

Network.....	23
Advanced Setting.....	23
System.....	24
Web Setup.....	25
Access the Web Interface of the Camera	25
Accessing the Camera via AVer IPCam Utility	25
Accessing the Camera via AVer PTZ Management	26
Live View	27
Camera Control.....	27
Preset	28
Camera Settings.....	29
Exposure.....	29
Image Process	30
Video & Audio	31
Network	33
Advanced Setting.....	36
SmartShoot.....	36
SmartFrame	37
Debug Information	38
NDI (model names with N only)	39
System.....	41
Appendix.....	43
VISCA RS-232 Command Table	43
Visca over IP Settings.....	48
CGI Command.....	49

Overview

Package Contents

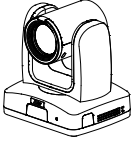

Camera

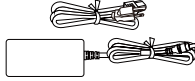

**Power Adapter &
Power Cord***



Remote Control

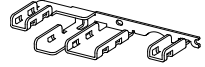

Cable Fixing Plate

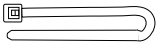

Cable Tie (x4)

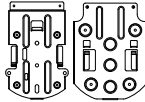

**Ceiling Mount
Bracket (x2)**

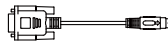

**DIN8 to D-Sub9
Cable**

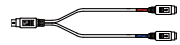

**RS-232 In/Out
Y Cable**



**M2 x 4mm
Screw (x3)**



**1/4"-20, L=6.5mm
Screw (x2)**



**M3 x 6mm
Screw (x3)**



Drill Template

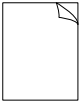

Quick Start Guide

*The power cord may vary based on the country or region where sold.

Optional Accessories*

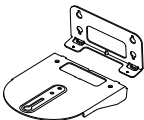

Wall Mount Bracket

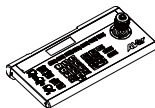

**Camera Controller
(CL01)**

*For details on optional accessories, please consult with your local dealer.

Parts Info

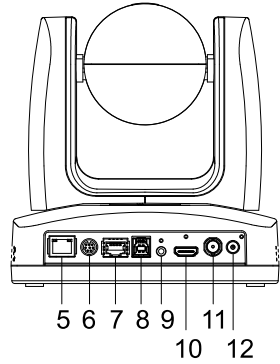
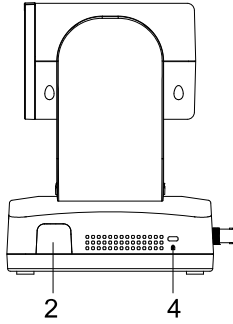
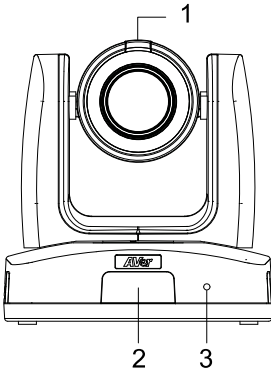

- 1. Tally Lamp
- 2. IR Sensor
- 3. LED Indicator

- 4. Kensington Lock

- 5. PoE+ IEEE 802.3AT
- 6. RS-232 Port
- 7. RS-422 Port
- 8. USB 3.0 Type-B Port
- 9. Audio In*
- 10. HDMI Port
- 11. 3G-SDI (unavailable for model names with H)
- 12. DC Power Jack

*Line input: 1Vrms max.

Mic input level: 50mVrms max.; supplied voltage: 2.5V.

LED Indicators

Color	Status
Solid blue	Normal
Flashing red	Firmware update
Solid orange	Standby
Flashing orange	Start-up
Flashing purple	SmartShoot
Flashing blue	SmartFrame

Remote Control

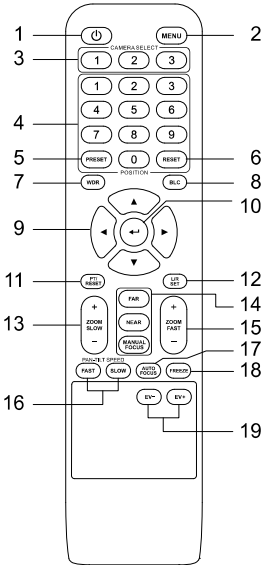

AAA Battery (x2)
(not included)

Name	Function
1. Power	Power on or enter standby mode.
2. Menu	Open and close the OSD menu during HDMI output.
3. Camera Select	No selection is required by default to operate the camera. <ul style="list-style-type: none"> Both camera and remote control have been set to 1. Specify a number in the OSD menu: System > Camera Selector.
4. Number Pad	Press number button (0-9) to move the camera to pre-configured preset position 0-9.
5. Preset	Press and hold Preset , then short press Number button (0-9) to save the preset position.
6. Reset	Press and hold Reset , then short press Number button (0-9) to reset preset position.
7. WDR	Turn Wide Dynamic Range on or off.
8. BLC	Turn Backlight Compensation on or off.
9. Directional Buttons	Press once for incremental movement or press and hold for continuous pan or tilt.
10. Enter	<ul style="list-style-type: none"> Confirm a selection in the OSD menu. Short press to turn on One Push Focus. Press and hold for 2 seconds to turn on SmartFrame. Note: Make sure SmartFrame has been turned on in the OSD menu or on the web interface for this shortcut to work.
11. PT Reset	Return the Pan-Tilt position to the home position.
12. L/R SET	<ul style="list-style-type: none"> Invert L/R Pan Direction: Press and hold L/R SET, then short press Position 2. Reset L/R Pan Direction: Press and hold L/R SET, then short press Position 1.
13. Zoom Slow +/-	Zoom in or out slowly.
14. Far / Near / Manual Focus	Enable manual focus. Use Far/Near to adjust the focus.
15. Zoom Fast +/-	Zoom in or out fast.
16. Pan-Tilt Speed Fast / Slow	Adjust pan-tilt speed.
17. Auto Focus	Autofocus.
18. Freeze	Freeze the live view.
19. EV +/-	<ul style="list-style-type: none"> Short press to adjust EV level. Long press EV+ to turn on RTMP. Long press EV- to turn off RTMP.

Dimensions

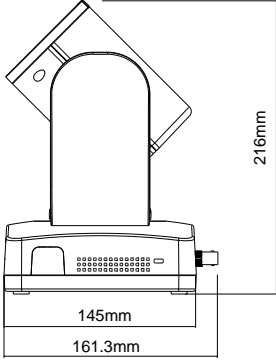
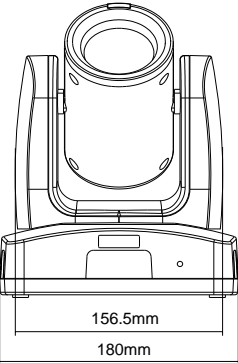
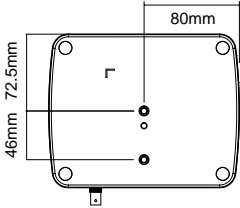
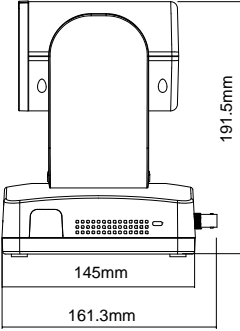
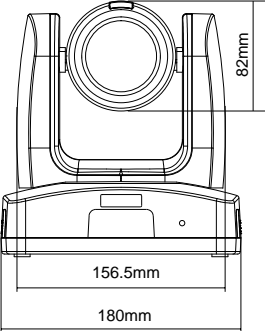

Ceiling Mount

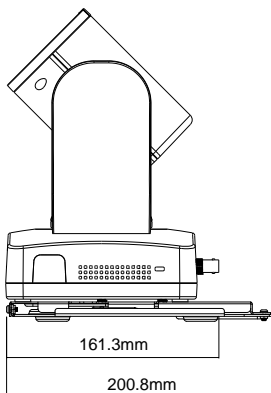
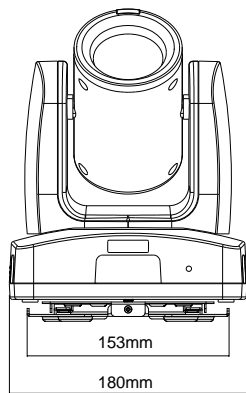
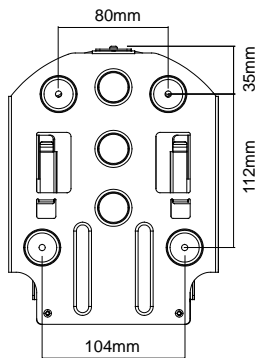
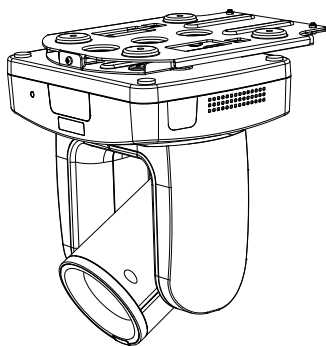

Wall Mount

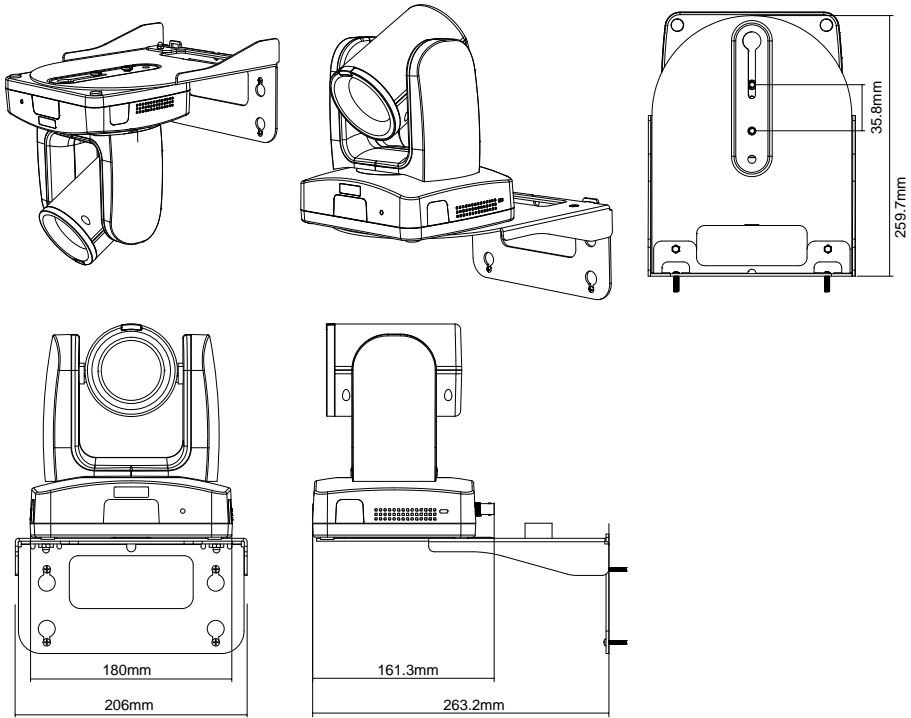

Pan and Tilt Angle

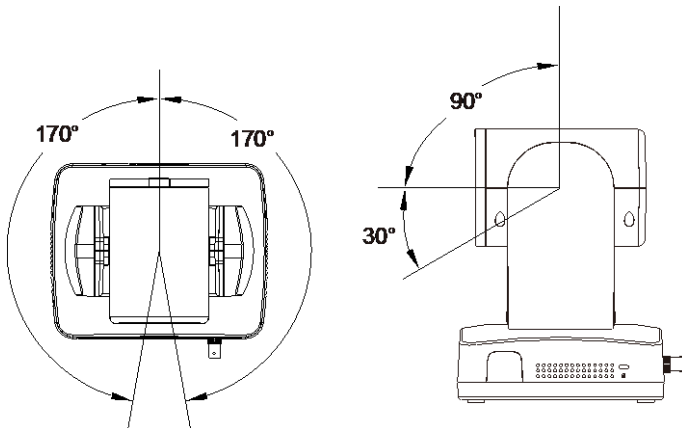

Connection

Device Connection

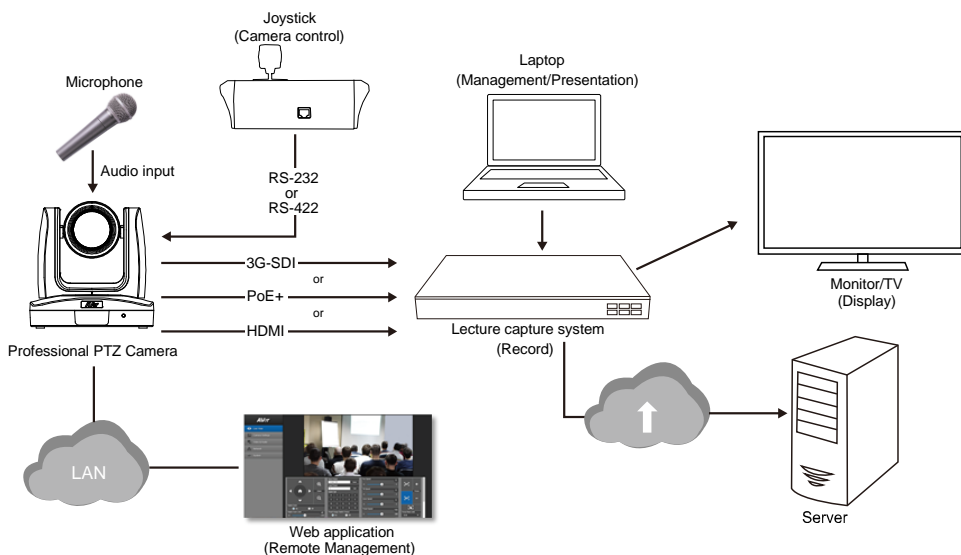

PoE Connection

Connect the camera to the router or switch through the PoE+ port.

[Note] Only support IEEE 802.3AT PoE+ standard.

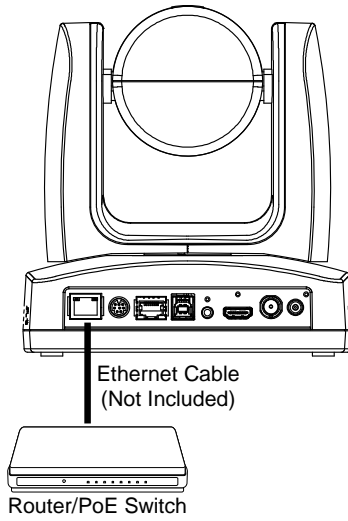

RS-232 and RS-422 Connection

Connect through the RS-232 or RS-422 for camera control.

- RS-232

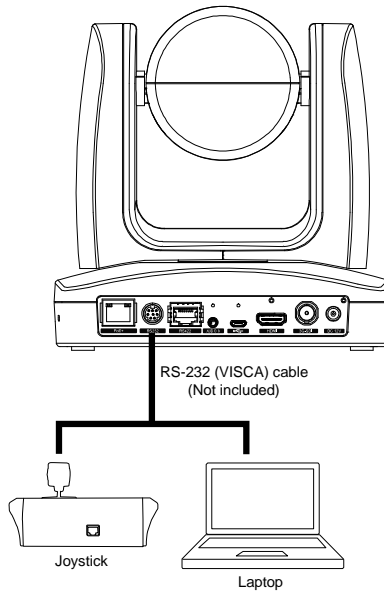

● **RS-232 Port Pin Definition**

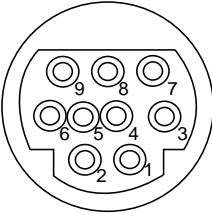

Function	Mini DIN9 PIN #	I/O Type	Signal	Description
VISCA IN	1	Output	DTR	Data Terminal Ready
	2	Input	DSR	Data Set Ready
	3	Output	TXD	Transmit Data
	6	Input	RXD	Receiver Data
VISCA OUT	7	Output	DTR	Data Terminal Ready
	4	Input	DSR	Data Set Ready
	8	Output	TXD	Transmit Data
	9	Input	RXD	Receiver Data
	5	Input	I/O	Detect DIN8/DIN9
---	Shield	---	GND	Ground

● **RS-232 mini DIN9 to mini DIN8 Cable Pin Definition**

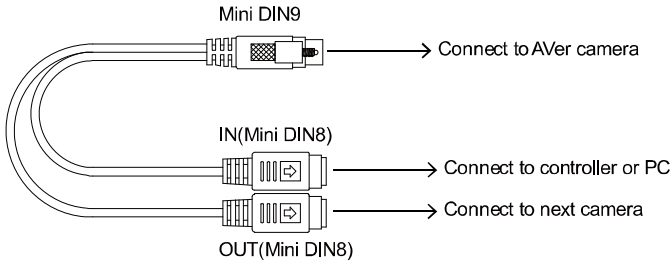

CIRCUITS:

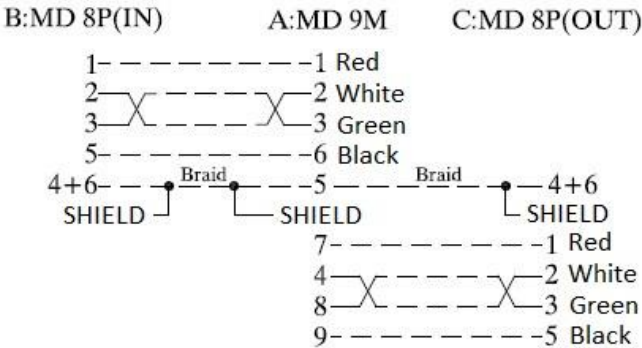

Mini DIN8 Cable Pin Definition

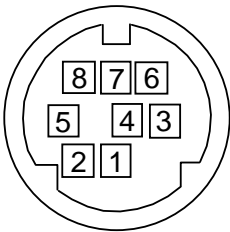

No.	Signal
1	DTR
2	DSR
3	TXD
4	GND
5	RXD
6	GND
7	NC
8	NC

● **Din8 to D-Sub9 Cable Pin Definition**

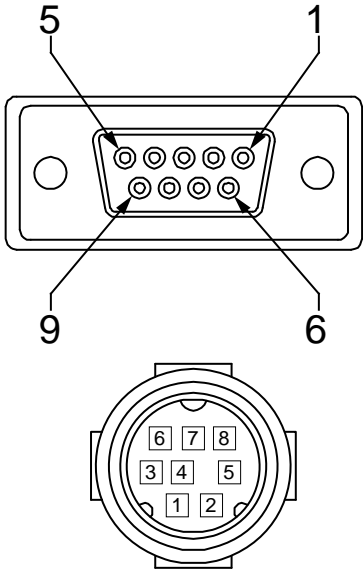

● RS-422

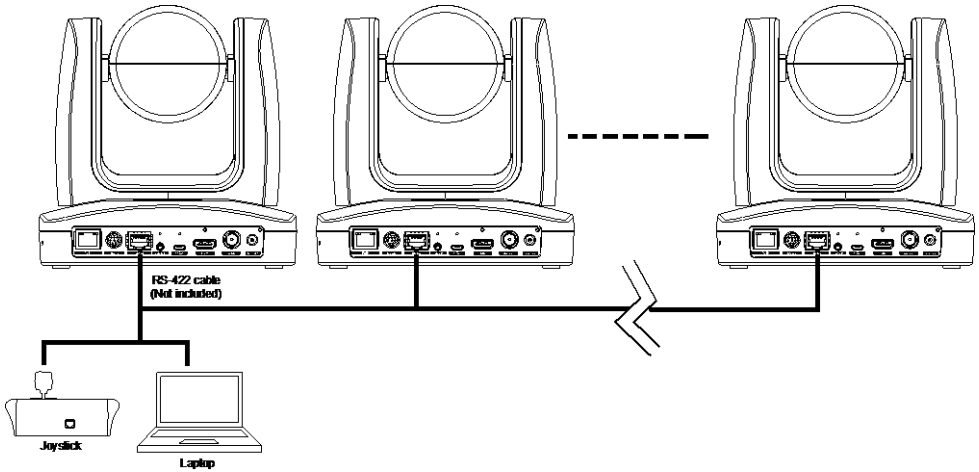

[Note] Use cat5e splitter for multi-camera connection.

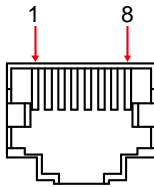

RS-422 Pin			
No.	Pin	No.	Pin
1	TX+	5	TX-
2	TX-	6	RX-
3	RX+	7	RX+
4	TX+	8	RX-

Cat5e splitter pin assignment:

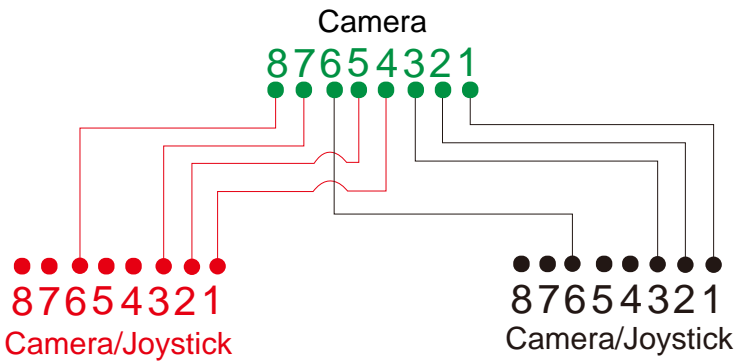

Audio Input Connection

Connect the audio device for audio receiving.

[Note]

- Line input level: 1Vrms (max.).
- Mic input level: 50mVrms (max.); Supplied voltage: 2.5V.

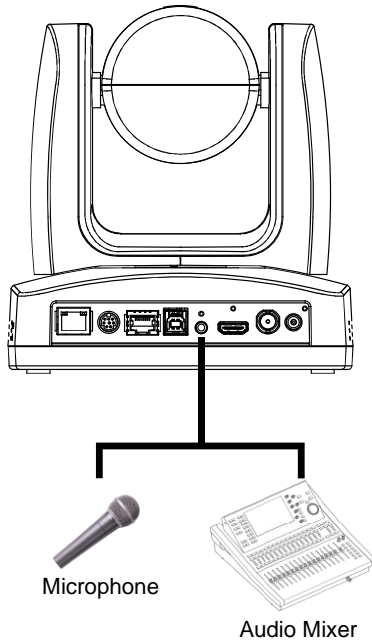

Video Output Connection

- **HDMI**

Use the HDMI cable to connect with monitor or TV for video output.

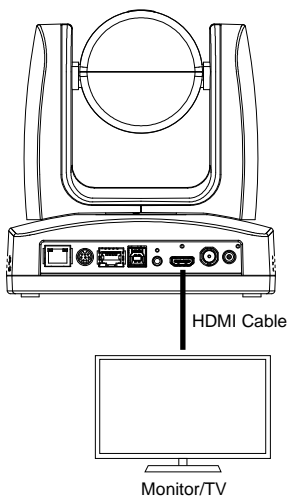

- **3G-SDI**

Connect to 3G-SDI monitor for video output.

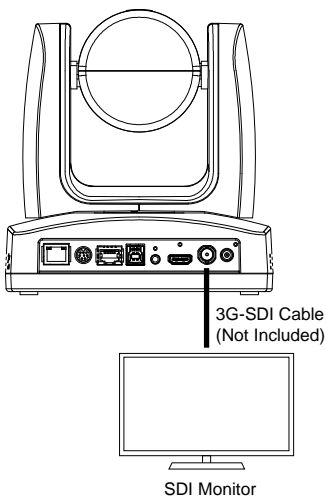

[Notes]

- HDMI and 3G-SDI monitors can be connected to camera and output live video simultaneously; Assuming HDMI monitor is well connected before the camera turned on, the OSD menu will be displayed on HDMI monitor in default.
- The model names with “H” do not have 3G-SDI.

Installation

Cable Fixing Plate Installation

1. Secure the cable fixing plate to the camera with 3 M2 x 4mm screws (included).

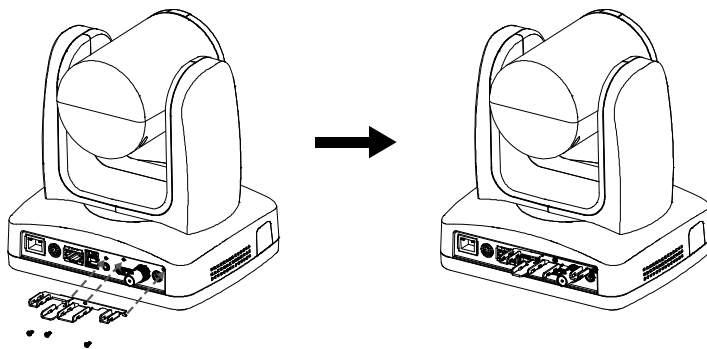

2. Plug in cables.

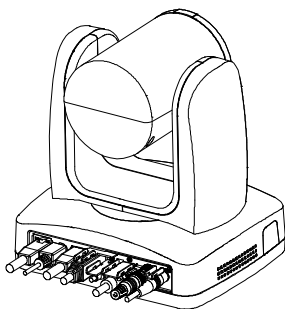

3. Use 4 cable ties to secure the cables and cable fixing plate.

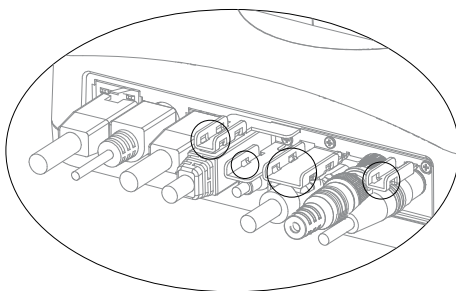

Ceiling Mount Installation

1. Secure the mount bracket on the ceiling.
Screw: 4 screws, M4 x 10mm (not Included)

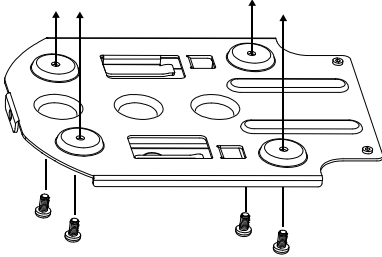

2. Install the mount bracket on the camera.
Screw: 2 screws, 1/4"-20 L=6.5mm (included)

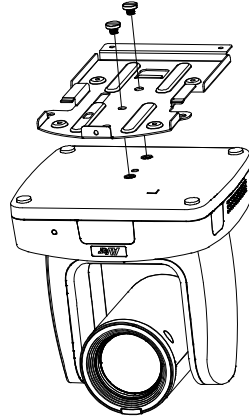

3. Slide the mount bracket with the camera into the mount bracket which secured on the ceiling.

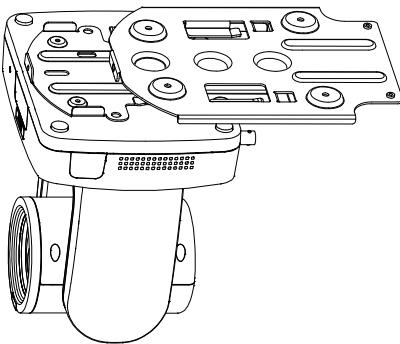

4. Secure the camera with screws.
Screw: 3 screws, M3 x 6mm (included)

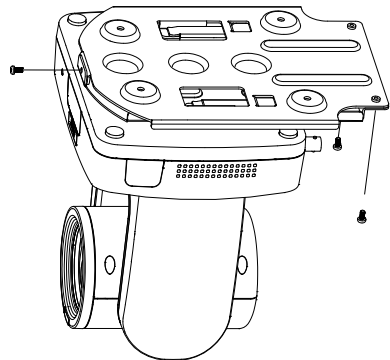

[Note] Connect necessary cables after sliding the camera into the mount bracket.

Camera Installation

- **Angle A:** less than 30°
- **Height B:** 2~3m from floor
- **Distance C:** longer than 3m away from podium
- **Position:** center of classroom
- **Distance between the camera and the target (presenter):**

Optical zoom ratio ability	Upper body size	Full body size
12X	3-16m	3-28m
16X	3-30m	4-55m
21X	3-40m	4-65m
30X	3-44m	3-76m

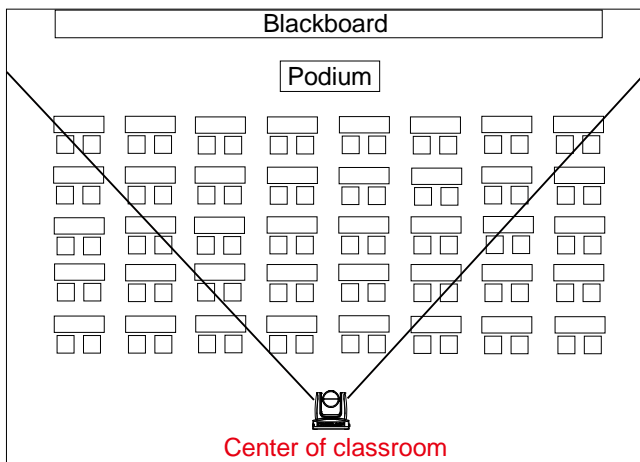
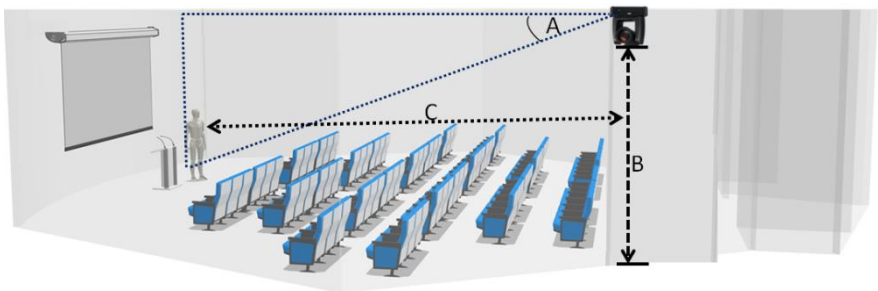

Set Up the Camera

OSD Menu

You can use the supplied Remote Control to operate the OSD Menu. Press the **MENU** button to call out the OSD menu and use the **▲**, **▼**, **◀**, **▶** and **↩** buttons to operate the OSD menu.



IP Address Setup

Static IP

1. Press the **MENU** button on the remote control to call out the OSD menu.
2. Go to **Network > Static IP**.

[Note] Turn the DHCP off before setting up static IP (**Network > DHCP > Off**).

3. Select the **IP Address**, **Gateway**, **Netmask** and **DNS** to configure. Press **↩** and use **◀**, **▶** and Numeric Pad to enter the data.



DHCP

1. Press the **MENU** button on the remote control to call out the OSD menu.
2. Go to **Network > DHCP > On**.

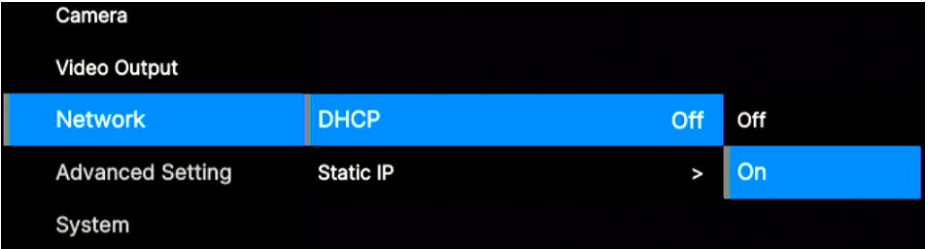

3. After turning the DHCP on, the user can go to **System > Information** to view the IP address.

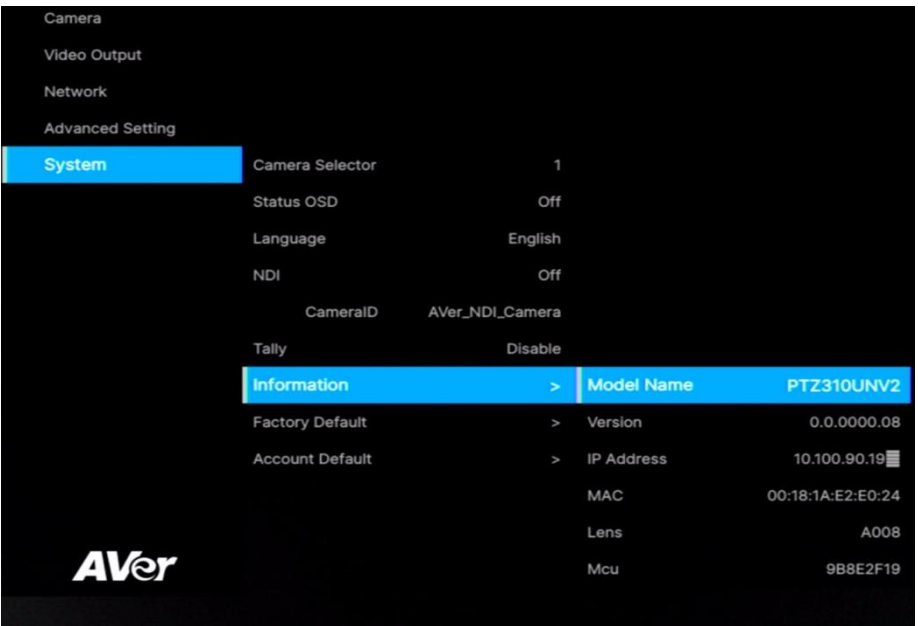

OSD Menu Tree

Camera

Set up camera parameters – Exposure Mode, White Balance, Pan Tilt Zoom, Noise Reduction, Saturation, Contrast, Sharpness, Mirror and Flip.

1 st Layer	2 nd Layer	3 rd Layer	4 th Layer	5 th Layer
Camera	Exposure Mode	Full Auto	Exposure Value	-4/-3/-2/-1/0/1/2/3/4
			Gain Limit Level	24dB/27dB/30dB/33dB/36dB /39dB/42dB
			Slow Shutter	Off/On
		Shutter Priority	Exposure Value	-4/-3/-2/-1/0/1/2/3/4
			Shutter Speed	60Hz: 1/1, 1/2, 1/4, 1/8, 1/15, 1/30, 1/60, 1/90, 1/100, 1/125, 1/180, 1/250, 1/350, 1/500, 1/725, 1/1000, 1/1500, 1/2000, 1/3000, 1/4000, 1/6000, 1/10000,
				50Hz: 1/1, 1/2, 1/3, 1/6, 1/12, 1/25, 1/50, 1/75, 1/100, 1/120, 1/150, 1/215, 1/300, 1/425, 1/600, 1/1000, 1/1250, 1/1750, 1/2500, 1/3500, 1/6000, 1/10000
			Gain Limit Level	24dB/27dB/30dB/33dB/36dB /39dB/42dB
		Iris Priority	Exposure Value	-4/-3/-2/-1/0/1/2/3/4
			Iris Level	F1.6/F2.0/F2.4/F2.8/ F3.4/F4.0/F4.8/F5.6/F6.8/ F8.0/F9.6/F11/F14/Close
			Gain Limit Level	24dB/27dB/30dB/33dB/36dB /39dB/42dB
			Slow Shutter	On/Off
		Manual	Shutter Speed	60Hz: 1/1, 1/2, 1/4, 1/8, 1/15, 1/30, 1/60, 1/90, 1/100, 1/125, 1/180, 1/250, 1/350, 1/500, 1/725, 1/1000, 1/1500, 1/2000, 1/3000, 1/4000, 1/6000, 1/10000,

1 st Layer	2 nd Layer	3 rd Layer	4 th Layer	5 th Layer
				50Hz: 1/1, 1/2, 1/3, 1/6, 1/12, 1/25, 1/50, 1/75, 1/100,1/120,1/150,1/215, 1/300, 1/425, 1/600, 1/1000, 1/1250, 1/1750, 1/2500, 1/3500, 1/6000, 1/10000
			Iris Level	F1.6 /F2.0/F2.4/F2.8/ F3.4/F4.0/F4.8/F5.6/F6.8/ F8.0/F9.6/F11/F14/Close
			Gain Level	0 dB/3 dB/6 dB/9 dB/12 dB /15 dB/18 dB/21 dB/24dB/ 27dB/30dB/33dB/36dB/39dB /42dB
		Bright	0-31	-
	White Balance	Auto	-	-
		ATW	-	-
		Indoor	-	-
		Outdoor	-	-
		One push	-	-
		Manual	R Gain (0-255)	-
		B Gain (0-255)	-	
	Pan Tilt Zoom	Preset Speed	5/25/50/100/150/ 200	-
		Digital Zoom	Off/On	-
		Digital Zoom Limit	-	-
		Pan/Tilt Slow	Off/On	-
	Noise Reduction	Off/Low/Medium/High	-	-
	Saturation	0-10	-	-
	Contrast	0-4	-	-
	Sharpness	0-3	-	-
	Mirror	Off/On	-	-
Flip	Off/On	-	-	

Video Output

Select video resolution (4K (2160p) is available for model names with U only).

1 st Layer	2 nd Layer	3 rd Layer
Video Output	Theme Mode	Standard, ZOOM, Teams, NDI HX3
	Frequency	50 Hz, 59.94 Hz, 60 Hz
	Resolution	2160P/60, 2160P/59, 2160P/50, 2160P/30, 2160P/29, 2160P/25, 1080P/60, 1080P/59, 1080P/50, 1080P/30, 1080P/29, 1080P/25, 1080I/60, 1080I/59, 1080I/50, 720P/60, 720P/59, 720P/50,

Network

Set up IP mode – DHCP or static IP.

1 st Layer	2 nd Layer	3 rd Layer
Network	DHCP	Off/On
	Static IP	IP Address, Gateway, Mask, DNS

Advanced Setting

1 st Layer	2 nd Layer	3 rd Layer	4 th Layer
Advanced Setting	Audio	Input Type	Line In
			MIC In
		Auto Gain Control	Off/On
		Noise Suppression	Off/Low/Normal
		Audio Volume	0-10
	Control	Serial Port	RS-232/RS-422
		Protocol	VISCA/PELCO D/PELCO P
		Camera Address	1-7
		Baud Rate	2400/4800/9600/38400
	SmartShoot	Off/On	
SmartFrame	Off/On		

System

- **Status OSD:** Enable/disable Preset status (Save Preset, Call Preset, Cancel Preset) display on the screen.
- **Camera Selector:** Set the camera ID 1~3 for using remote control on multiple cameras control (also see No.3 Camera Select in Remote Control chapter).
- **NDI:** Enable/disable NDI function.
- **Tally:** Enable tally function.
- **Account Default:** If you forget your password for the web interface, use Account Default to reset it to **admin/admin**.

1 st Layer	2 nd Layer	3 rd Layer
System	Camera Selector	1-3
	Status OSD	Off/On
	Language	English/繁體中文/日本語/简体中文/한국어/ Tiếng Việt
	NDI	Off/On
		Camera ID
	Tally	Disable/Enable
	Information	Model Name/Version/IP Address/MAC/Lens/Mcu
	Factory Default	Off/On
Account Default	Off/On	

Web Setup

Connect the camera from a remote site through the internet. Recommended browser: Chrome.

Access the Web Interface of the Camera

To access the Web interface of the camera, you have to find the IP address of the camera using **AVer IPCam Utility** or **AVer PTZ Management** software.

Accessing the Camera via AVer IPCam Utility

To find the IP address of your cameras using the IPCam Utility installer, follow the steps below.

1. Download the IPCam Utility from <https://www.aver.com/download-center> and run the IPCam Utility.
2. Click **Search**, and all available devices will be listed on the screen.
3. Select a camera from the list, the camera info will be displayed in the Settings field.

[Note] The default network of the camera is DHCP and the default ID/Password are **admin/admin**. If you want to configure the network to static IP (192.168.1.168), input the ID/Password in the **Login** field, select the "camera model" on the list, select "Static IP", enter the static IP related information, and then click the **Apply** button.

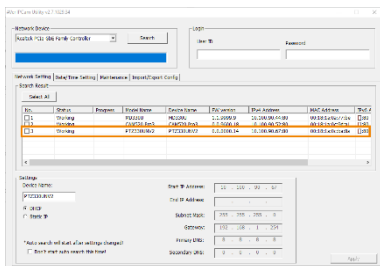

4. To access the Web interface, double-click on the IP address in the IPv4 Address column. For the first-time user, you will be prompted with a Login window to change the ID and password.

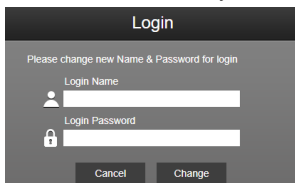

5. Login with the new ID/Password, the Web interface of the camera will be displayed. Please refer to the Live View chapter for more details.

[Note] If IPCam utility cannot find the camera, please check the following:

1. Please make sure the Ethernet connection of the camera is well connected.
2. The camera and PC (IPCam Utility) are in the same LAN segment.

Accessing the Camera via AVer PTZ Management

To find the IP address of your cameras using the AVer PTZ Management, follow the steps below.

1. Download the AVer PTZ Management software from <https://www.aver.com/download-center>
2. Download the Windows program and install it.
3. After setting up the user ID and password, log in to the software (default User Name/Password: admin/admin).

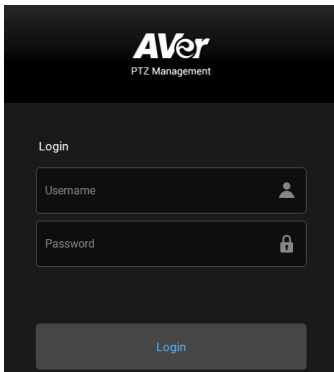

4. On the Main page of PTZ Management, click **Setup > Add** and then click **Auto Search**. The cameras connected on the same LAN with the computer will be displayed.

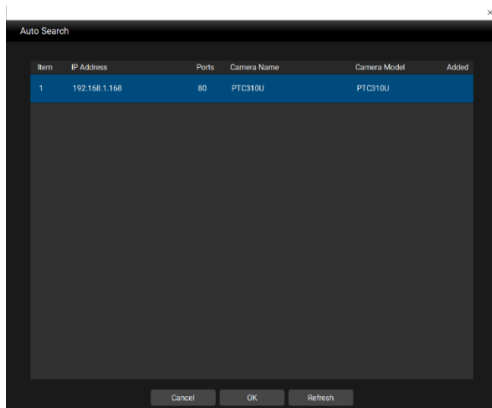
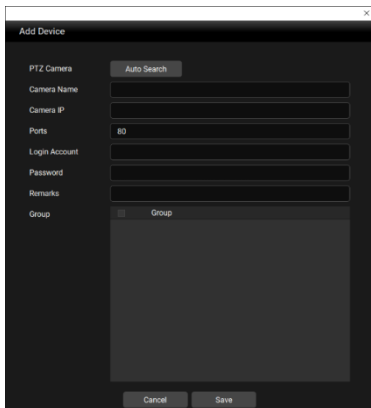

5. Click on the camera and input the camera ID and Password to add the camera to the device list (default ID/Password are admin/admin). Click the **Go to Web** button to access the Web interface of the camera.

Live View



Camera Control

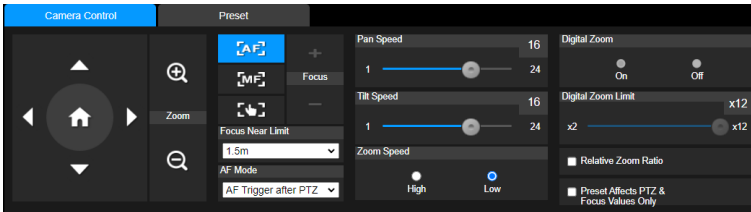

Item	Description
Pan and Tilt Controls ⬅️➡️⬆️⬇️	Position the camera. Drag the slider to adjust Pan Speed and Tilt Speed .
Home Position	Move the camera to the Home position.
Zoom	Zoom in or zoom out the live view and select Zoom Speed .
Auto Focus	Select Auto Focus and then choose an AF mode : <ul style="list-style-type: none"> ● AF Trigger after PTZ: Automatically focus after each pan, tilt or zoom. ● Continuous AF: Automatically focus continuously.
Manual Focus	Click to manually focus. Adjust the focus with + - buttons.
One Push Focus	Click to automatically focus once.
Focus Near Limit	Set up the nearest focus limit.
Digital Zoom	Turn digital zoom on or off.
Digital Zoom Limit	Adjust the digital zoom.
Relative Zoom Ratio	Select to automatically adjust pan and tilt speeds based on the zoom ratio.
Preset Affects PTZ &	A preset typically includes pan, tilt, zoom, focus, and 3A

Focus Values Only	(autofocus, autoexposure, auto white balance) values. Select to save only pan, tilt, zoom and focus values for presets.
-------------------	--

Preset

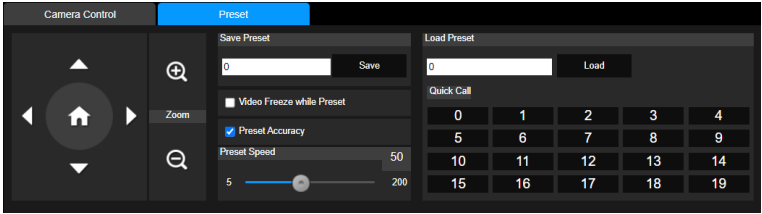

Item	Description
Save Preset	<ol style="list-style-type: none"> 1. Position the camera using pan, tilt and zoom controls. 2. Enter a preset number (0-255) in the Save Preset field and click Save.
Load Preset	<ol style="list-style-type: none"> 1. Enter a preset number (0-255) in the Load Preset field and click Load. 2. Or click a preset number (0~19) in the Quick Call section.
Video Freeze while Preset	Select to display only the live view from presets. The live view from the moving path will not be displayed.
Preset Accuracy	Select to improve the accuracy of moving to presets.
Preset Speed	Adjust the camera speed when moving to presets.

Camera Settings

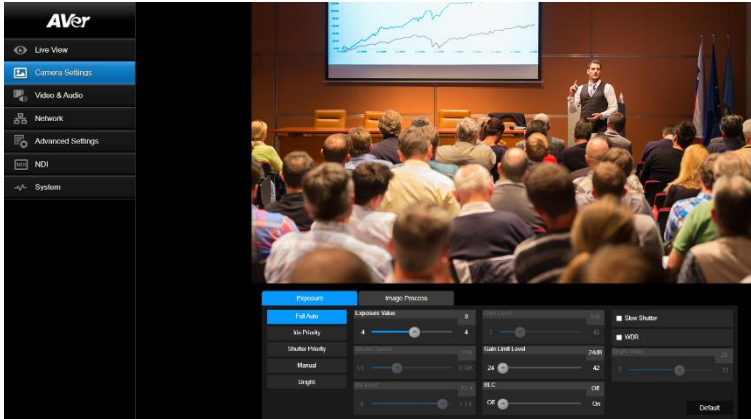

Exposure

Click **Default** to reset Exposure to factory default settings.

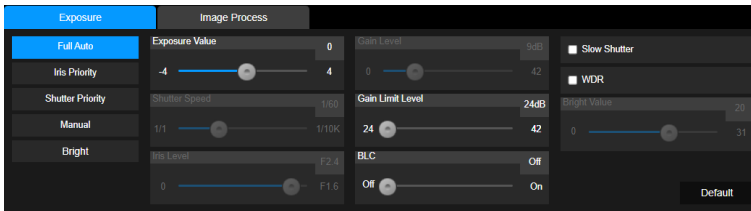

Item	Description
Exposure Mode	Choose an exposure mode.
Exposure Value	Adjust exposure, shutter, iris and gain.
Shutter Speed	
Iris Level	
Gain Level	
Gain Limit Level	Turn backlight compensation (BLC), slow shutter, wide dynamic range (WDR) on or off.
BLC	
Slow Shutter	
WDR	
Bright Value	Drag the slider to adjust the brightness value.

Image Process

Click **Default** to reset Image Process to factory default settings.

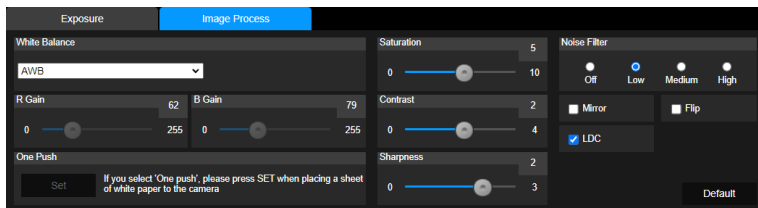

Item	Description
White Balance	<p>Choose a white balance mode</p> <ul style="list-style-type: none"> ● In Manual mode, you can also adjust the R Gain and B Gain. ● In One Push mode, place a piece of white paper in front of the camera lens and click Set to calibrate white balance.
Saturation	Adjust saturation, contrast and sharpness.
Contrast	
Sharpness	
Noise Filter	Select a noise filtering level.
Mirror	Turn mirror, flip or lens distortion correction (LDC) on or off.
Flip	
LDC	

Video & Audio

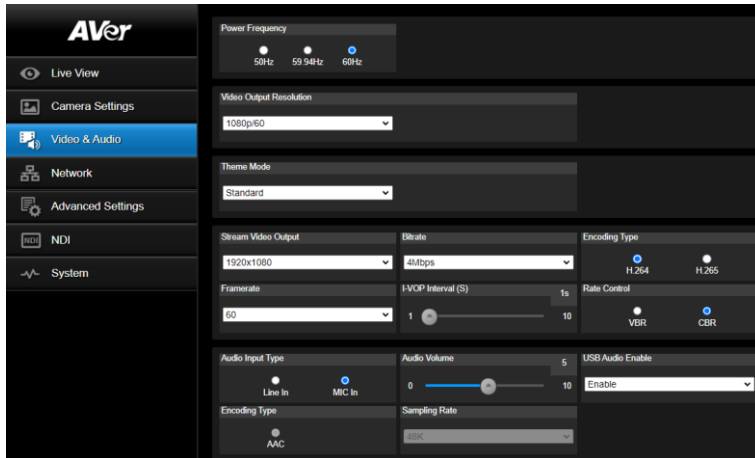

Video Setting

Item	Description
Power Frequency (Hz)	Select 50Hz , 59.94Hz or 60Hz based on your country or region.
Video Out Resolution	Choose a video output resolution. 4K (2160p) is available for model names with U only. RTSP: Max. 4K/60fps HDMI: Max. 4K/60fps
Theme Mode	Choose a video mode for Standard , ZOOM , Teams or NDI output.
Stream Video Output	Choose a streaming output resolution for the live view.
Bitrate	Choose a bitrate.
Encoding Type	Select H.264 or H.265 .
Framerate	Choose a framerate
I-VOP Interval (S)	Drag the slider to choose how often I-VOPs appear in a video stream. <ul style="list-style-type: none"> Shorter I-VOP intervals result in higher video quality but also larger file sizes.
Rate Control	Select Variable Bit Rate (VBR) or Constant Bit Rate (CBR).

Audio Setting

Item	Description
Audio Input Type	Select Line In or MIC In .
Audio Volume	Drag the slider to adjust the microphone volume.
USB Audio Enable	Turn off to stop transmitting audio over USB.
Encoding Type	AAC

Sampling Rate	48K
---------------	-----

Network

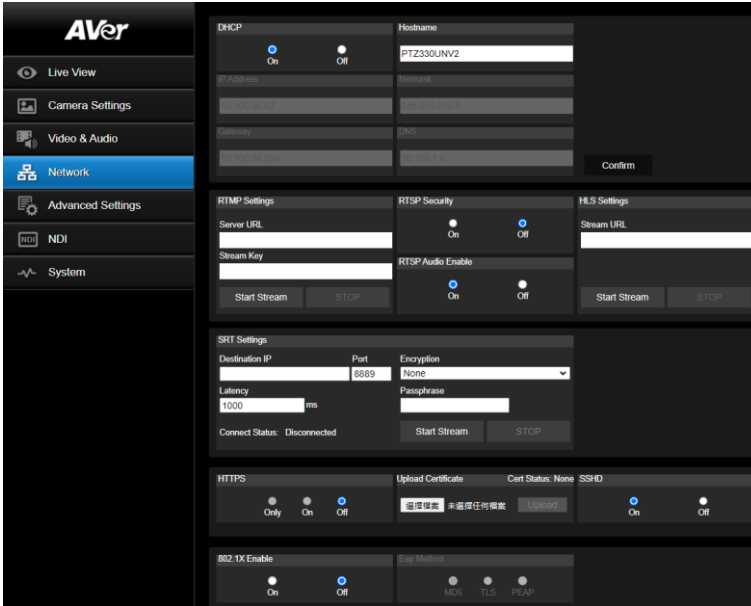

Item	Description
DHCP	<p>Set the network to DHCP or Static IP.</p> <ul style="list-style-type: none"> ● DHCP: Turn on DHCP and click Confirm to save the setting. The camera will be assigned IP settings automatically. ● Static IP: Turn off DHCP, enter IP Address, Netmask, Gateway and DNS, and click Confirm to save the settings.
Hostname	<p>Enter a hostname that is displayed on devices such as an IP router.</p> <ul style="list-style-type: none"> ● The default is your model name.
RTMP Setting	<p>Stream live video to a video platform such as YouTube.</p> <ol style="list-style-type: none"> 1. Enter the Server URL and Stream Key of your video platform. Please refer to the instruction of your platform to obtain the server URL and stream key. 2. Click Start Stream to start streaming, Stop to stop streaming.
RTSP Security	<p>Protect your video stream on media players such as VLC, PotPlayer and QuickTime by ensuring that only authorized users can access it.</p> <ul style="list-style-type: none"> ● When Security is turned off: <ol style="list-style-type: none"> 1. Enter your camera's RTSP URL into the media player. 2. RTSP URL: rtsp://[camera IP address]/live_st1 Example: rtsp://192.168.1.100/live_st1 ● When Security is turned on: <ol style="list-style-type: none"> 1. Enter your camera's RTSP URL and username/password into the

	<p>media player.</p> <ol style="list-style-type: none"> RTSP URL: rtsp://[username:password]@[camera IP address]/live_st1 Example: rtsp://1:1@192.168.1.100/live_st1 username/password: camera's username/password (web interface login)
--	--

HLS Settings	<p>Configure HTTP Live Streaming (HLS) settings to provide adaptive bitrate streaming, which ensures smooth playback and minimizes buffering.</p> <ol style="list-style-type: none"> Enter the stream URL obtained from the streaming service or server. Click Start Stream to start streaming, Stop to stop streaming.
--------------	---

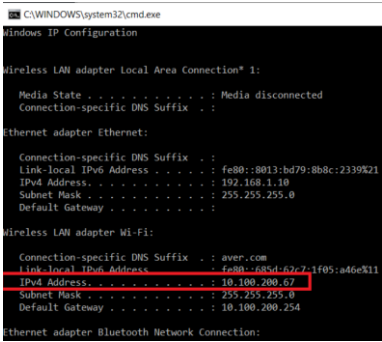
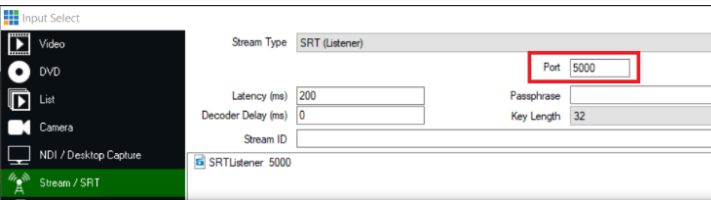
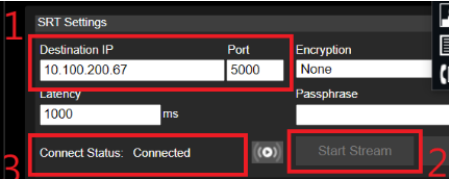
SRT Settings	<ul style="list-style-type: none"> vMix <ol style="list-style-type: none"> Make sure the vMix workstation and your camera are on same network. Copy the workstation's IP address.  <ol style="list-style-type: none"> Go to Stream tab > select SRT (Listener) from the Stream Type drop-down list. Copy the Port value.  <ol style="list-style-type: none"> Paste the IP address and Port value into SRT Settings fields and click Start Stream. Connect Status will change to Connected.  <ul style="list-style-type: none"> OBS (Open Broadcaster Software)
--------------	--

1. Make sure the OBS workstation and your camera are on same network. Copy the workstation's IP address.

```

Connection-specific DNS Suffix . : aver.com
Link-local IPv6 Address . . . . . : fe80::f1dc:bda:87bd:acle%1
IPv4 Address. . . . . : 10.100.105.127
Subnet Mask . . . . . : 255.255.255.0
Default Gateway . . . . . : 10.100.105.254

```

2. Open OBS. Add a scene and a source.
3. Enter "srt://[Workstation IP]:[port]?mode=listener" in the **Input** field.
Example: srt://10.100.105.127:8889?mode=listener

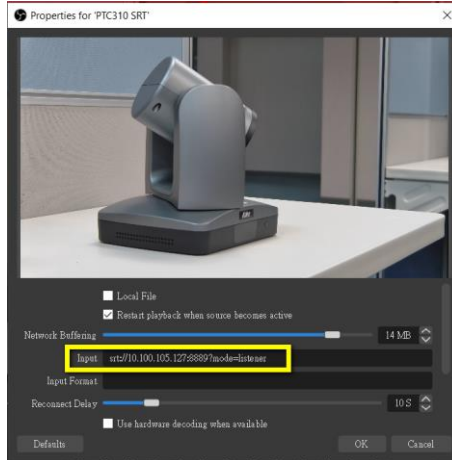

4. If there is no image, right-click on the source > **Transform** > **Fit to screen** to re-scale image.

HTTPS	<p>Enable HTTPS to establish a secure connection between your browser and your camera. To enable HTTPS access on your camera:</p> <ol style="list-style-type: none"> 1. Obtain a SSL certificate for encryption and decryption in base-64 encoded format and use a private key in PKCS#8 format (unencrypted). 2. Package the required certificate content into PEM format. The SSL certificate uploaded to the camera must be in PEM format. 3. Click Browse to select the certificate file, and then click Upload. 4. Turn on HTTPS.
SSHD	Turn remote debugging from AVer on or off.
802.1x Enable	Turn 802.1x Enable on or off.
Eap Method	When 802.1x Enable is turned on, select an Eap method.
Eap Setting	Based on your Eap method, complete the authentication and click Confirm .

Advanced Setting

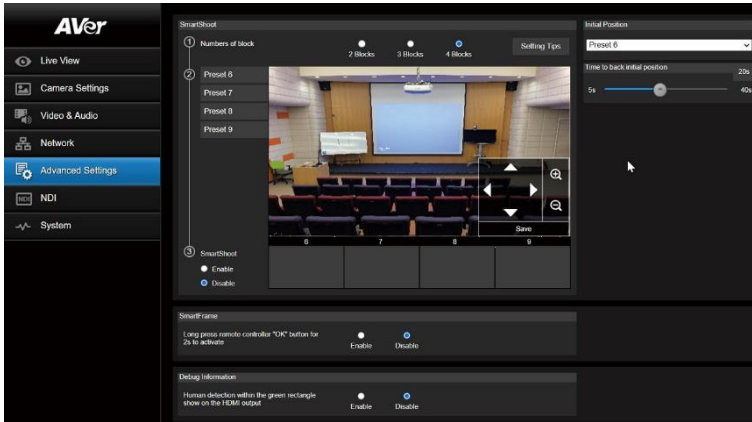

SmartShoot

Setup the block area for the camera to detect object and follow-up the object to move the camera when the object is in block area that user has set.

1. In the advanced setting interface, select the **Number of block** (2, 3, or 4). Each block is corresponding to one preset position. The maximum is 4 blocks (4 preset positions).

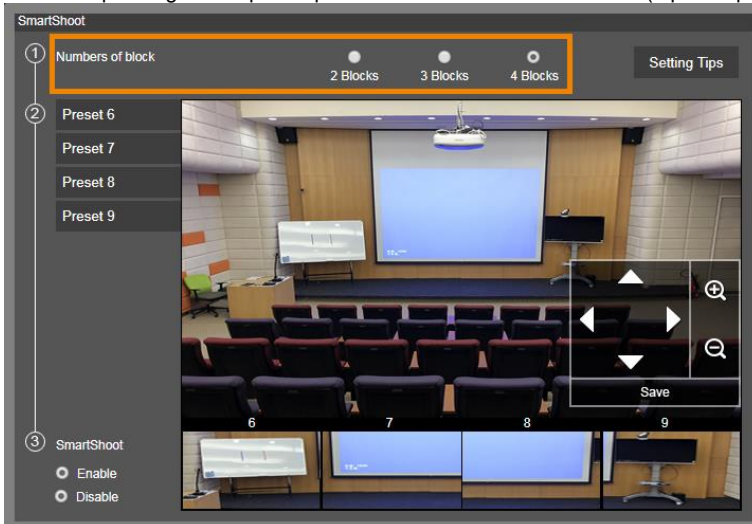

- Set the preset positions in order (Preset 6 to Preset 9). Use direction control panel to move the camera to wanted position and select “save” to save the preset position. And, a snapshot of the preset image will show at corresponding image display box. Repeat the step to set another preset position.

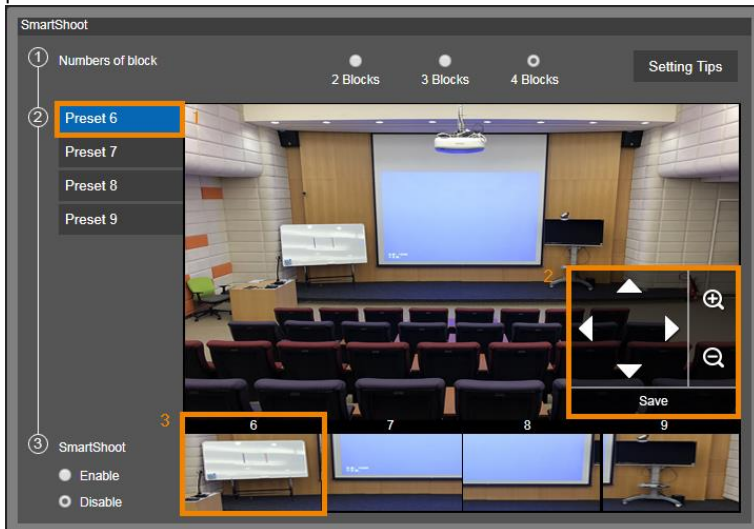

- Set the **Initial Position** and **Time to back initial position**. The camera will go back to initial position based on the time set at Time to back initial position.

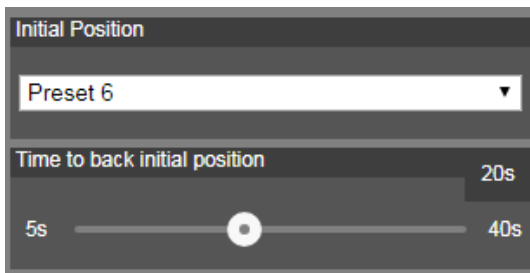

- Select **Enable** to turn on SmartShoot. Or turn on SmartShoot in the OSD menu: **Advanced Setting > SmartShoot > On**.

SmartFrame

Press  button on the remote control to enable to auto focus the face of object and zoom in. Select **Enable** to turn on SmartFrame.

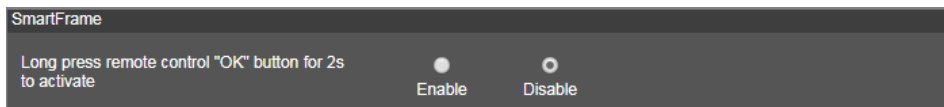

Debug Information

Select **Enable**, and the human detection within the green rectangle will show on the HDMI output.

NDI (model names with N only)

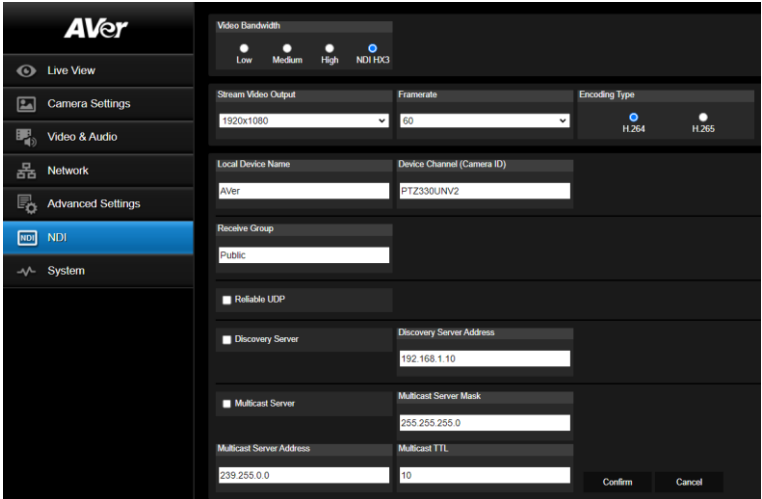

Item	Description
Video Bandwidth	Select a bandwidth. NDI HX3 is a protocol that enables high-quality video streaming over IP networks.
Stream Video Output	Choose a streaming output resolution for the live view. 4K (2160p) is available for model names with U only.
Framerate	Choose a framerate.
Encoding Type	Select H.264 or H.265 .
Local Device Name	Enter a name that identifies your camera group on the NDI software. <ul style="list-style-type: none"> The default is AVer.
Device Channel (Camera ID)	Enter a name that identifies your camera on the NDI software. <ul style="list-style-type: none"> The default is your model name. A name must have no more than 10 characters. Use number, upper and lower case letter, or special character (! @ % ^ , . / : + ? [] { } - _ ~).
Receive Group	Enter a name for a receive group. <ul style="list-style-type: none"> All devices in the receive group receive the same NDI streams. The receive group should remain public. If this is changed, you will need to join the group through NDI® Access Manager.
Reliable UDP	Select the checkbox to enable Reliable User Datagram Protocol (RUDP).
Discovery Server	Select the checkbox to enable discovery server to allow devices to discover and connect to each other on a network

	automatically.
Discovery Server Address	Enter the IP address of a server running a discovery server application.
Multicast Server	Select the checkbox to enable multicast server to allow efficient distribution of NDI streams to multiple receivers without overwhelming the network.
Multicast Server Mask	Enter the network mask to specify the range of IP addresses that are eligible to receive NDI streams.
Multicast Server Address	Enter the IP address of a group of recipients that receive NDI streams from a multicast server.
Multicast TTL	Enter a multicast time to live (TTL) value between 1-255 to control the distance multicast packets can travel.

System

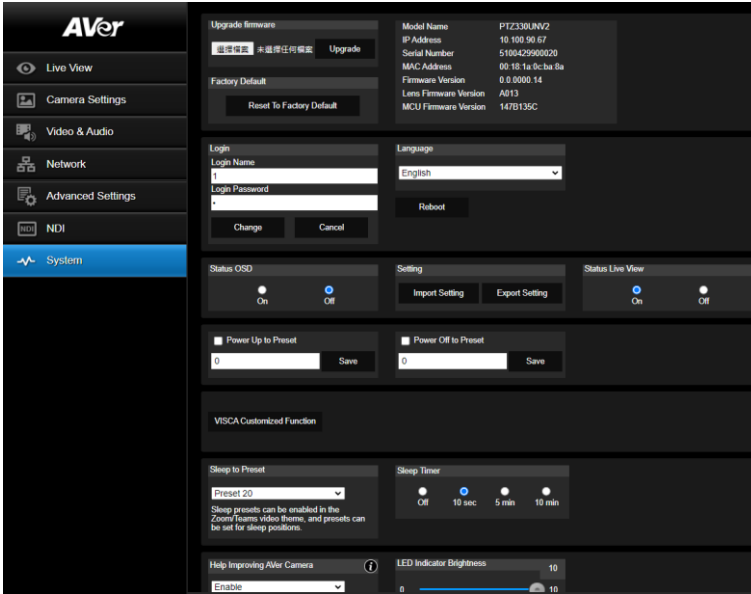

Item	Description
Upgrade Firmware	To upgrade the firmware: <ol style="list-style-type: none"> 1. Download the latest firmware from AVer Download Center (https://www.aver.com/download-center). 2. On the web interface, go to System > Upgrade firmware. 3. Click Browse to select the firmware. 4. Click Upgrade. 5. Refresh the browser after the upgrade is complete. <p>[Note] Keep your camera connected to a power source during firmware upgrade. Network connection will be lost during the process and camera will reboot automatically after upgrading.</p>
Factory Default	Reset the camera to factory default settings.
Login	<ul style="list-style-type: none"> ● The default username/password is admin/admin. ● To change the username/password, enter the new username/password and click Change. Passwords must have no more than 32 characters. Use number or upper and lower case letter.
Language	Change the web interface language.
Reboot	Restart your camera.
Status OSD	Enable to display preset, zooming, SmartShoot and SmartFrame status on HDMI output.
Setting	Export or import your camera settings

Status Live View	Turn the camera live view on or off.
Power Up to Preset	Move the camera to the defined preset after powering on. To enable: <ol style="list-style-type: none"> 1. Make sure the preset has been defined. 2. Select Power Up to Preset > enter a preset number > click Save.
Power Off to Preset	Move the camera to the defined preset before powering off. To enable: <ol style="list-style-type: none"> 1. Make sure the preset has been defined. 2. Select Power Off to Preset > enter a preset number > click Save.
VISCA Customized Function	Set VISCA customized functions and click OK .
Sleep to Preset	When no video is transmitted over USB on Zoom or Teams, set up Sleep to Preset and Sleep Timer to move the camera to a defined preset after a period of time for enhanced privacy. <ul style="list-style-type: none"> ● To enable: <ol style="list-style-type: none"> 1. Make sure the preset has been defined. 2. Go to Video & Audio > Theme Mode > choose Zoom or Teams. 3. Go to Systems > Sleep to Preset > choose a preset. 4. Go to Systems > Sleep Timer > select a duration. ● To disable, choose Off from the Sleep to Preset drop-down list or select Off in Sleep Timer.
Sleep Timer	
Help Improving AVer Camera	Opt-in or opt-out of providing anonymous usage data.
LED Indicator Brightness	Drag the slider to adjust the brightness.

Appendix

VISCA RS-232 Command Table

Command Set	Command	Command Packet	Comments
CAM_Power	On	8x 01 04 00 02 FF	Power ON/OFF
	Off	8x 01 04 00 03 FF	
CAM_Zoom	Stop	8x 01 04 07 00 FF	p=0 (Low) to 7 (High) pqrs: Zoom Position · PTC310: 0x0000~0x6f20 PTC330: 0x0110~0x5490
	Tele(Variable)	8x 01 04 07 2p FF	
	Wide(Variable)	8x 01 04 07 3p FF	
	Direct	8x 01 04 47 0p 0q 0r 0s FF	
CAM_Focus	Stop	8x 01 04 08 00 FF	Each 'Far/Near' needs a 'stop'
	Far (Standard)	8x 01 04 08 02 FF	
	Near (Standard)	8x 01 04 08 03 FF	
	Auto Focus	8x 01 04 38 02 FF	
	Manual Focus	8x 01 04 38 03 FF	
	One Push	8x 01 04 18 01 FF	
	Direct	8x 01 04 47 0p 0q 0r 0s FF	
CAM_WB	Auto	8x 01 04 35 00 FF	Normal Auto
	ATW	8x 01 04 35 04 FF	
	Indoor	8x 01 04 35 01 FF	
	Outdoor	8x 01 04 35 02 FF	
	One Push WB	8x 01 04 35 03 FF	One Push WB mode
	Manual	8x 01 04 35 05 FF	Manual Control mode
	One Push	8x 01 04 10 05 FF	One Push WB Trigger
CAM_RGain	Up	8x 01 04 03 02 FF	Manual Control of R Gain
	Down	8x 01 04 03 03 FF	
CAM_Bgain	Up	8x 01 04 04 02 FF	Manual Control of B Gain
	Down	8x 01 04 04 03 FF	
CAM_AE	Full Auto	8x 01 04 39 00 FF	Automatic Exposure mode
	Manual	8x 01 04 39 03 FF	Manual Control mode
	Shutter Priority	8x 01 04 39 0A FF	Shutter Priority Automatic Exposure mode
	Iris Priority	8x 01 04 39 0B FF	Iris Priority Automatic Exposure mode

Command Set	Command	Command Packet	Comments
	Bright	8x 01 04 39 0D FF	Bright Mode (Manual control)
CAM_Shutter	Up	8x 01 04 0A 02 FF	Shutter Setting
	Down	8x 01 04 0A 03 FF	
CAM_Iris	Up	8x 01 04 0B 02 FF	Iris Setting
	Down	8x 01 04 0B 03 FF	
CAM_Gain	Up	8x 01 04 0C 02 FF	Gain Setting
	Down	8x 01 04 0C 03 FF	
CAM_Bright	Up	8x 01 04 0D 02 FF	Bright Setting
	Down	8x 01 04 0D 03 FF	
	Up	8x 01 04 0E 02 FF	Exposure Compensation Amount Setting
	Down	8x 01 04 0E 03 FF	
CAM_Backlight	On	8x 01 04 33 02 FF	Back Light Compensation ON/OFF
	Off	8x 01 04 33 03 FF	
CAM_Preset	Reset	8x 01 04 3F 00 pp FF	pp: Preset Number 0x00~0xFF
	Set	8x 01 04 3F 01 pp FF	
	Recall	8x 01 04 3F 02 pp FF	
CAM_Menu	On/Off	8x 01 06 06 10 FF	Display ON/OFF
Pan-tilt Drive	Up	8x 01 06 01 VV WW 03 01 FF	VV: Pan speed setting 0x01 (low speed) to 0x18 (high speed) WW: Tilt speed setting 0x01 (low speed) to 0x18 (high speed)
	Down	8x 01 06 01 VV WW 03 02 FF	
	Left	8x 01 06 01 VV WW 01 03 FF	
	Right	8x 01 06 01 VV WW 02 03 FF	
	UpLeft	8x 01 06 01 VV WW 01 01 FF	
	UpRight	8x 01 06 01 VV WW 02 01 FF	
	DownLeft	8x 01 06 01 VV WW 01 02 FF	
	DownRight	8x 01 06 01 VV WW 02 02 FF	
	Stop	8x 01 06 01 VV WW 03 03 FF	
	Home	8x 01 06 04 FF	
	Reset	8x 01 06 05 FF	
CAM_WDR	On	8x 01 04 3D 02 FF	Wdr ON/OFF
	Off	8x 01 04 3D 03 FF	
CAM_MenuEnter		8x 01 7E 01 02 00 01 FF	Enter Submenu
Tally Lamp ON		8x 01 7E 01 0A 00 02 FF	
Tally Lamp OFF		8x 01 7E 01 0A 00 03 FF	
Freeze	Freeze On	81 01 04 62 02 FF	Freeze On Immediately
	Freeze Off	81 01 04 62 03 FF	Freeze Off Immediately

Command Set	Command	Command Packet	Comments
	Preset Freeze On	81 01 04 62 22 FF	Freeze On When Running Preset
	Preset Freeze Off	81 01 04 62 23 FF	Freeze Off When Running Preset
CAM_Memory Special	Set	8x 01 04 3F 01 pp FF	These are changeable depending on VISCA Customized Functions web setting: pp: 0x00 To 0xFF normal preset pp: 0x5F => Trun on OSD menu
Absolute Position	Set	8x 01 06 02 VV WW 0Y 0Y 0Y 0Y 0Z 0Z 0Z 0Z FF	VV: Pan speed setting 0x01 (low speed) to 0x18 (high speed) WW: Tilt speed setting 0x01 (low speed) to 0x18 (high speed) YYYY: Pan Position ZZZZ: Tilt Position
RTMP	On	8x 01 04 A2 02 FF	
	Off	8x 01 04 A2 03 FF	
Video mode	IP+Stream	8x 01 04 A3 00 FF	
	USB only	8x 01 04 A3 01 FF	
	NDI only	8x 01 04 A3 02 FF	
	Streaming only	8x 01 04 A3 03 FF	
Reboot	On	8x 01 04 A4 FF	
Preset Affects PTZ & Focus Values Only	On	8x 01 04 A5 02 FF	
	Off	8x 01 04 A5 03 FF	
Relative Zoom Ratio	On	8x 01 04 A6 02 FF	
	Off	8x 01 04 A6 03 FF	

Inquiry Command	Command Packet	Reply Command Packet	Comments
CAM_PowerInq	8x 09 04 00 FF	y0 50 02 FF	On
		y0 50 03 FF	Off
CAM_WBModelInq	8x 09 04 35 FF	y0 50 00 FF	Auto
		y0 50 01 FF	In Door
		y0 50 02 FF	Out Door
		y0 50 03 FF	One Push WB
		y0 50 04 FF	ATW
		y0 50 05 FF	Manual
CAM_RGainInq	8x 09 04 43 FF	y0 50 00 00 0p 0q FF	pp: R Gain
CAM_BGainInq	8x 09 04 44 FF	y0 50 00 00 0p 0q FF	pp: B Gain
CAM_AEModelInq	8x 09 04 39 FF	y0 50 00 FF	Full Auto
		y0 50 03 FF	Manual
		y0 50 0A FF	Shutter Priority
		y0 50 0B FF	Iris Priority
		y0 50 0D FF	Bright
CAM_ShutterPosInq	8x 09 04 4A FF	y0 50 00 00 0p 0q FF	pp: Shutter Position
CAM_IrisPosInq	8x 09 04 4B FF	y0 50 00 00 0p 0q FF	pp: Iris Position
CAM_GainPosInq	8x 09 04 4C FF	y0 50 00 00 0p 0q FF	pp: Gain Position
CAM_BrightPosInq	8x 09 04 4D FF	y0 50 00 00 0p 0q FF	pp: Bright Position
CAM_ExpCompPosInq	8x 09 04 4E FF	y0 50 00 00 0p 0q FF	pp: ExpComp Position
CAM_FocusModelInq	8x 09 04 38 FF	y0 50 02 FF	Auto Focus
		y0 50 03 FF	Manual Focus
CAM_FocusPosInq	8x 09 04 48 FF	y0 50 0p 0q 0r 0s FF	pqrs: Focus Position
zoom_Pos_Inq	8x 09 04 47 FF	y0 50 0p 0q 0r 0s FF	pqrs: Zoom Position
PT_Pos_Inq	8x 09 06 12 FF	y0 50 0Y 0Y 0Y 0Y 0Z 0Z	YYYY: Pan Position
		0Z 0Z FF	ZZZZ: Tilt Position
CAM_Preset Inq	8x 09 04 3F FF	y0 50 pp FF	Return the last preset number which has been operated pp:01-FF
CAM_OSD MENU on/off	8x 09 7E 04 76 01 FF	y0 50 02 FF	On
		y0 50 03 FF	Off
CAM_Tally	8x 09 7E 01 0A FF	y0 50 02 FF	On
		y0 50 03 FF	Off
CAM_WDR mode	8x 09 04 3D FF	y0 50 02 FF	On

Inquiry Command	Command Packet	Reply Command Packet	Comments
		y0 50 03 FF	Off
CAM_BLC mode	8x 09 04 33 FF	y0 50 02 FF	On
		y0 50 03 FF	Off
CAM_Live Freeze	8x 09 04 62 01 FF	y0 50 02 FF	Freeze On
		y0 50 03 FF	Freeze Off
CAM_Preset Freeze	8x 09 04 62 02 FF	y0 50 02 FF	Preset Freeze On
		y0 50 03 FF	Preset Freeze Off
Firmware version	8x 09 36 69 04 FF	y0 50 0p 0q 0r 0s 0t 0u 0v 0w FF	fw_ver: p.q.rstu.vw
USB Status	8x 09 36 69 05 FF	y0 50 00 FF	USB cable plug out
		y0 50 01 FF	USB cable plug in
UVC Status	8x 09 36 69 06 FF	y0 50 00 FF	UVC stream off
		y0 50 01 FF	UVC stream on

Visca over IP Settings

PORT

Internet protocol	IPv4
Transport protocol	UDP
Port address	52381

FORMAT

	byte 0	byte 1	byte 2	byte 3	byte 4	byte 5	byte 6	byte 7	byte8 ~~~ byte23	
func	Payload type		Payload length		Sequence number			Payload (1 to 16 bytes)		
data	Value1	Value2	1~16 (0x0001~0x0010)		0X00000000 ~ 0XFFFFFFF			VISCA Packet (see page VISCA)		

Payload type

Name	Value1	Value2	Description
VISCA command	0x01	0x00	Stores the VISCA command.
VISCA inquiry	0x01	0x10	Stores the VISCA inquiry.
VISCA reply	0x01	0x11	Stores the reply for the VISCA command or VISCA inquiry

CGI Command

CGI List for Video Transmission					
CGI item name	URL	Command	Parameter Name	Parameter value	Description
Get JPEG	/snapshot				1280x720 jpg
Get RTSP stream	rtsp://ip/live_st1				
Get MJPG	http://IP/html/live.html				

CGI List for Camera Control					
CGI item name	URL	Command	Parameter Name	Parameter value	Description
up start	/cgi-bin?SetPtfz=	1,0,1&(random)			
up end	/cgi-bin?SetPtfz=	1,0,2&(random)			
down start	/cgi-bin?SetPtfz=	1,1,1&(random)			
down end	/cgi-bin?SetPtfz=	1,1,2&(random)			
left start	/cgi-bin?SetPtfz=	0,1,1&(random)			
left end	/cgi-bin?SetPtfz=	0,1,2&(random)			
right start	/cgi-bin?SetPtfz=	0,0,1&(random)			
right end	/cgi-bin?SetPtfz=	0,0,2&(random)			
zoom_in start	/cgi-bin?SetPtfz=	2,0,1&(random)			
zoom_in end	/cgi-bin?SetPtfz=	2,0,2&(random)			
zoom_out start	/cgi-bin?SetPtfz=	2,1,1&(random)			
zoom_out end	/cgi-bin?SetPtfz=	2,1,2&(random)			
set preset:	/cgi-bin?ActPreset=	1,N&(random)			N : position
load preset:	/cgi-bin?ActPreset=	0,N&(random)			N : position
set preset speed	/cgi-bin?Set=preset_speed,3,val	val: {min: 1, max: 6}			
Absolute Position (Pan)	/cgi-bin?Set=ptz_p,3,val	val: {min: 2048, mid: 962944, max: 1925888}			Follows CGI preset speed
Absolute Position (Tilt)	/cgi-bin?Set=ptz_t,3,val	val: {min: 2048, mid: 165696, max: 662784}			Follows CGI preset speed

Absolute Position (Zoom)	/cgi-bin?Set=ptz_z,3, val	val: {min: 2048, mid: 14224, max: 28448}			Follows CGI preset speed
--------------------------	---------------------------	--	--	--	--------------------------

CGI List for Various Settings					
exposure value	/cgi-bin?Set=	img_expo_expo,3,N&(random)	value	1 ~ 9	N : value
saturation	/cgi-bin?Set=	img_saturation,3,N&(random)	value	0 ~ 10	N : value
contrast	/cgi-bin?Set=	img_contrast,3,N&(random)	value	0 ~ 4	N : value
Reboot	GET(Basic Authentication)	/cgi-bin?OnePush=!			
Factory Reset	GET(Basic Authentication)	/cgi-bin?OnePush=d			
RTMP Start streaming	/cgi-bin?Set=	vdo_rtmp_enable,3,1			
RTMP Stop streaming	/cgi-bin?Set=	vdo_rtmp_enable,3,0			
Save RTMP server URL		/cgi-bin?SaveRtmpUrl=		value empty for clearing up the field	
Save RTMP stream Key		/cgi-bin?SaveRtmpKey=		value empty for clearing up the field	
Inquiry for RTMP status		/cgi-bin?Get=vdo_rtmp_status		Streaming: vdo_rtmp_status =2 Stopped: vdo_rtmp_status =0	
Get RTMP server URL		/cgi-bin?GetRtmpUrl			
Get RTMP stream key		/cgi-bin?GetRtmpKey			
USB status	GET(Basic Authentication)	/cgi-bin?Get=usb_status_inquire,3			
	- Reply	"usb_status_inquire,3=X\r\n"	X: 0(plug out), 1(plug in)		
UVC status	GET(Basic Authentication)	/cgi-bin?Get=uvc_status_inquire,3			
	- Reply	"uvc_status_inquire,3=X\r\n"	X: 0(stream off), 1(stream on)		
Status get (Model name & mac & FW_VER)		/cgi-bin?SetString=sys_name&net_mac&sys_fw_version&_=1635216271678		http://10.100.105.110/cgi-bin?GetString=sys_name&net_mac&sys_fw_version&_=1635216271678	

Serial No. get		/cgi-bin?GetSerialNumber&_=1635216271680		http://10.100.105.110/cgi-bin?GetSerialNumber&_=1635216271680	
script (Using cURL to update firmware)	curl.exe -X POST --user NAME:PASSWORD -F file1=@./ISP_FILE "http://IP_ADDRESS/system/"			Please download curl (curl for Windows), this is a command line tool for network transferring. Put curl.exe and ISP file in the same folder. and then execute the script to upgrade camera. For example, ISP file is 0.0.000.29.dat , IP address is 10.100.105.109 and username:password is 1:1 , you can enter this script to execute ISP process. curl.exe -X POST --user 1:1 -F file1=@./0.0.000.0.29.dat "http://10.100.105.109/system/"	